

<i>litalo</i> <b>Mottola</b> <i>handcrafted stringed instruments</i>			m@LitaloMottola.com		
TITLE: Mezzaluna Electric Bass Family Standard - 34' scale					
Drawn by: RMM		Date: 4/26/02			
Code Ident No:		Size: 24 x 48	Drawing No:		
Scale: 1:1		Sheet 1 of 1			

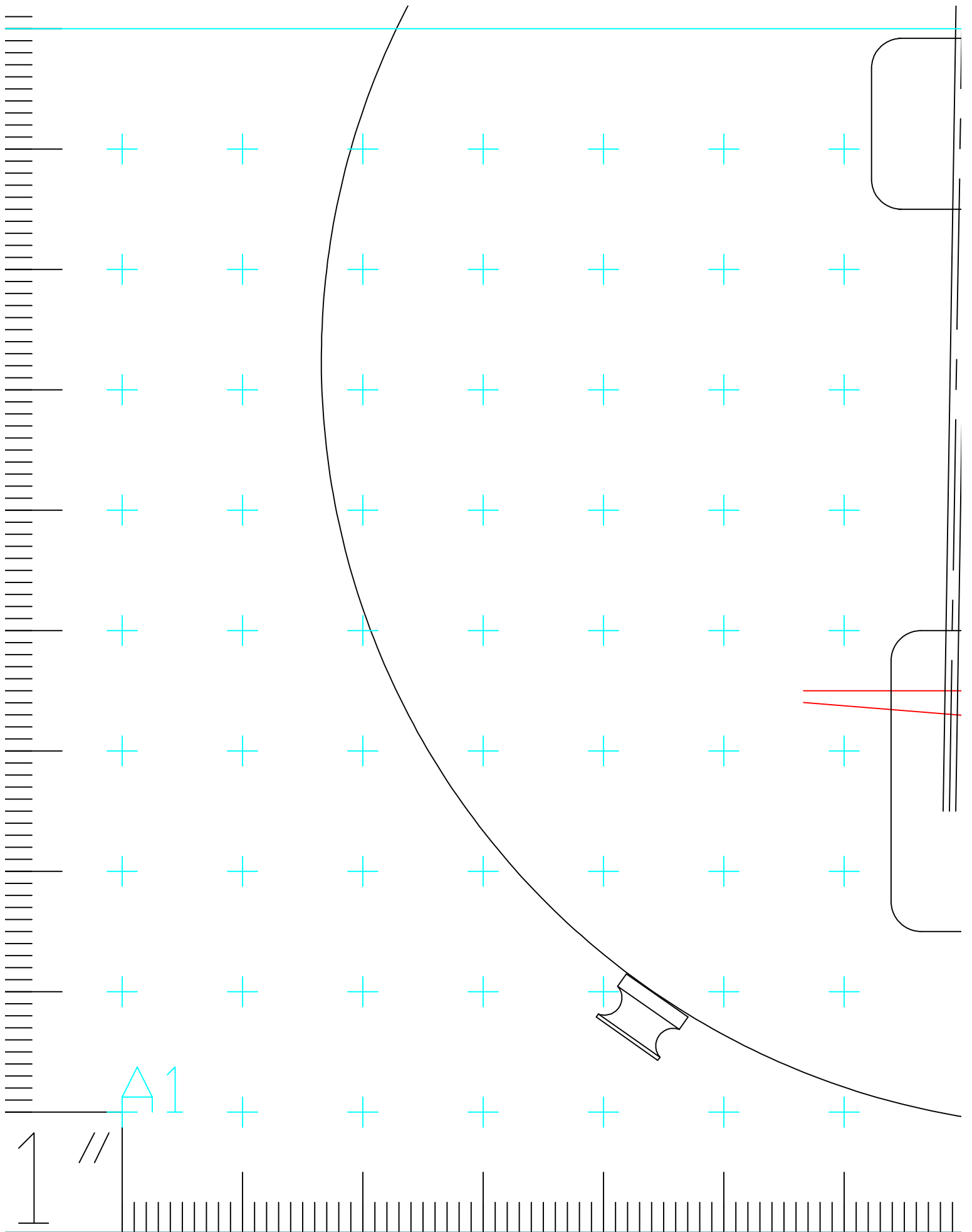

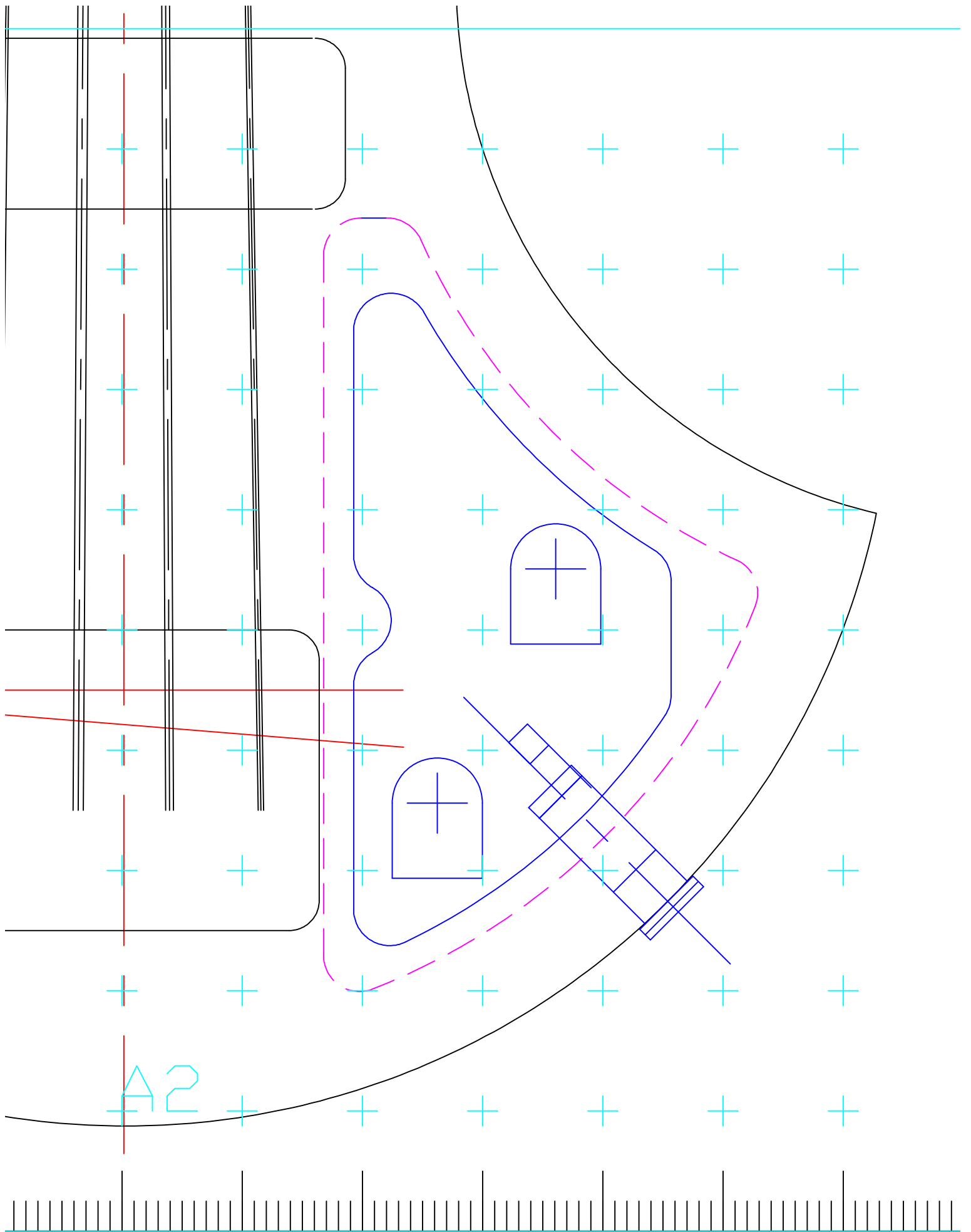

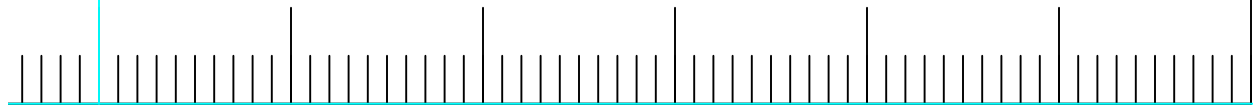

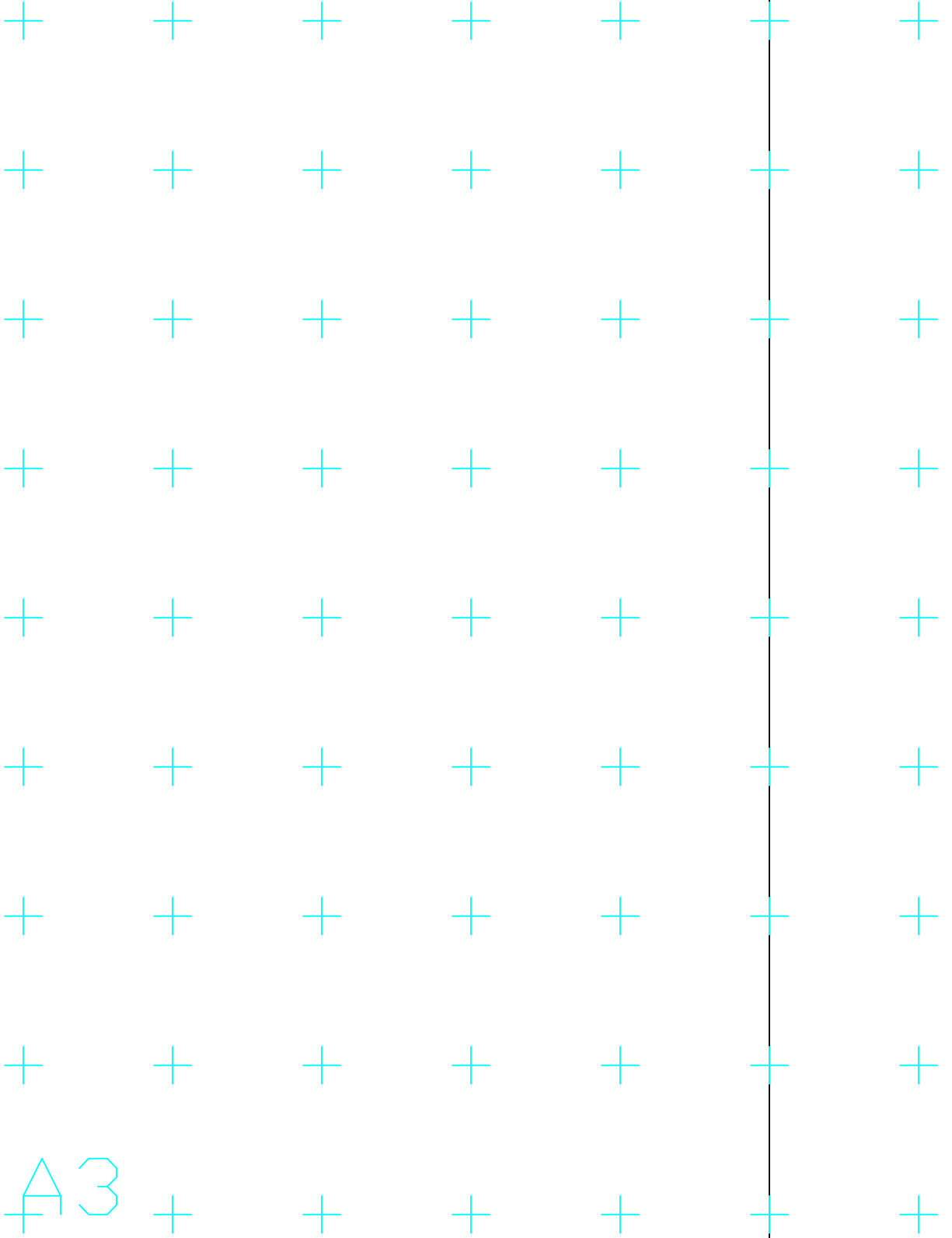
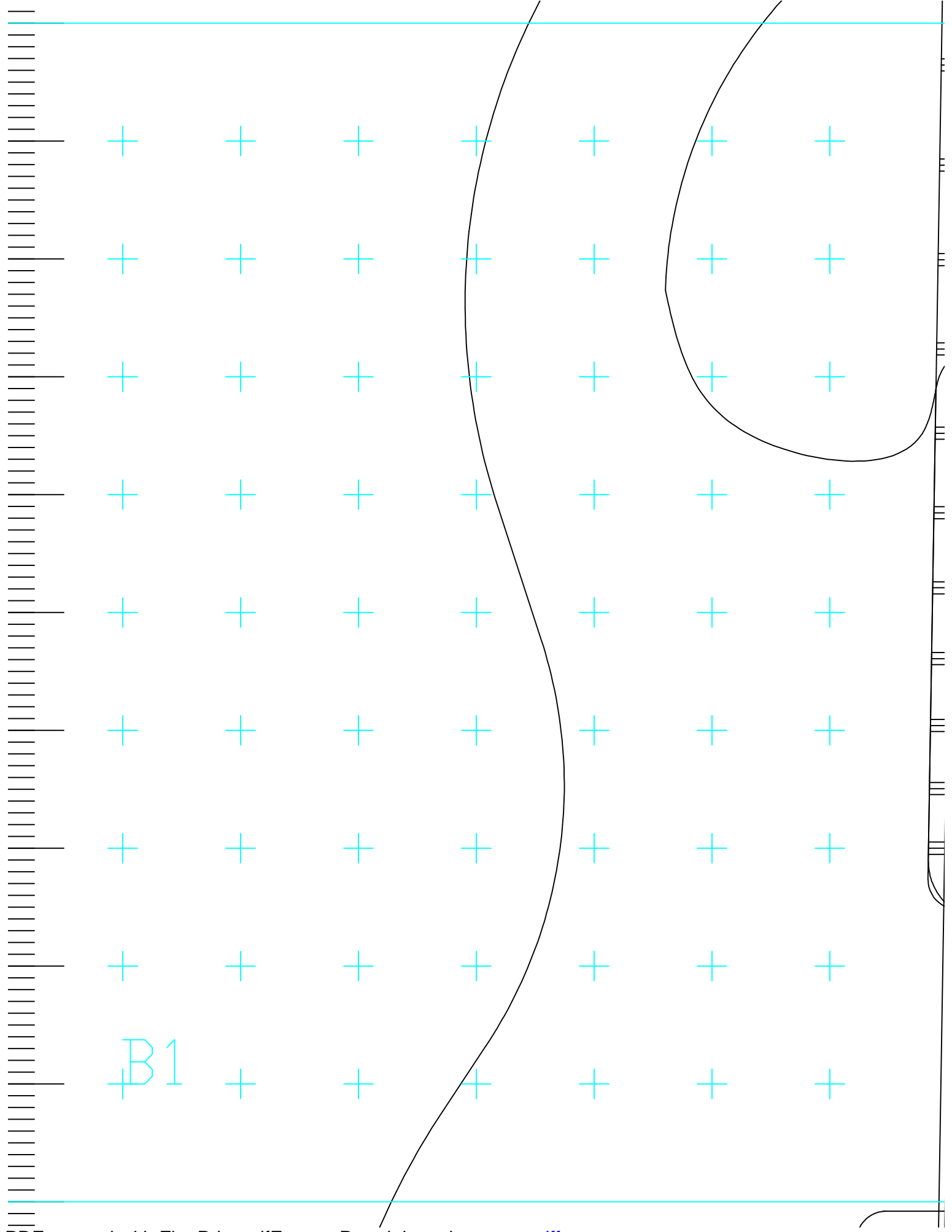

B1

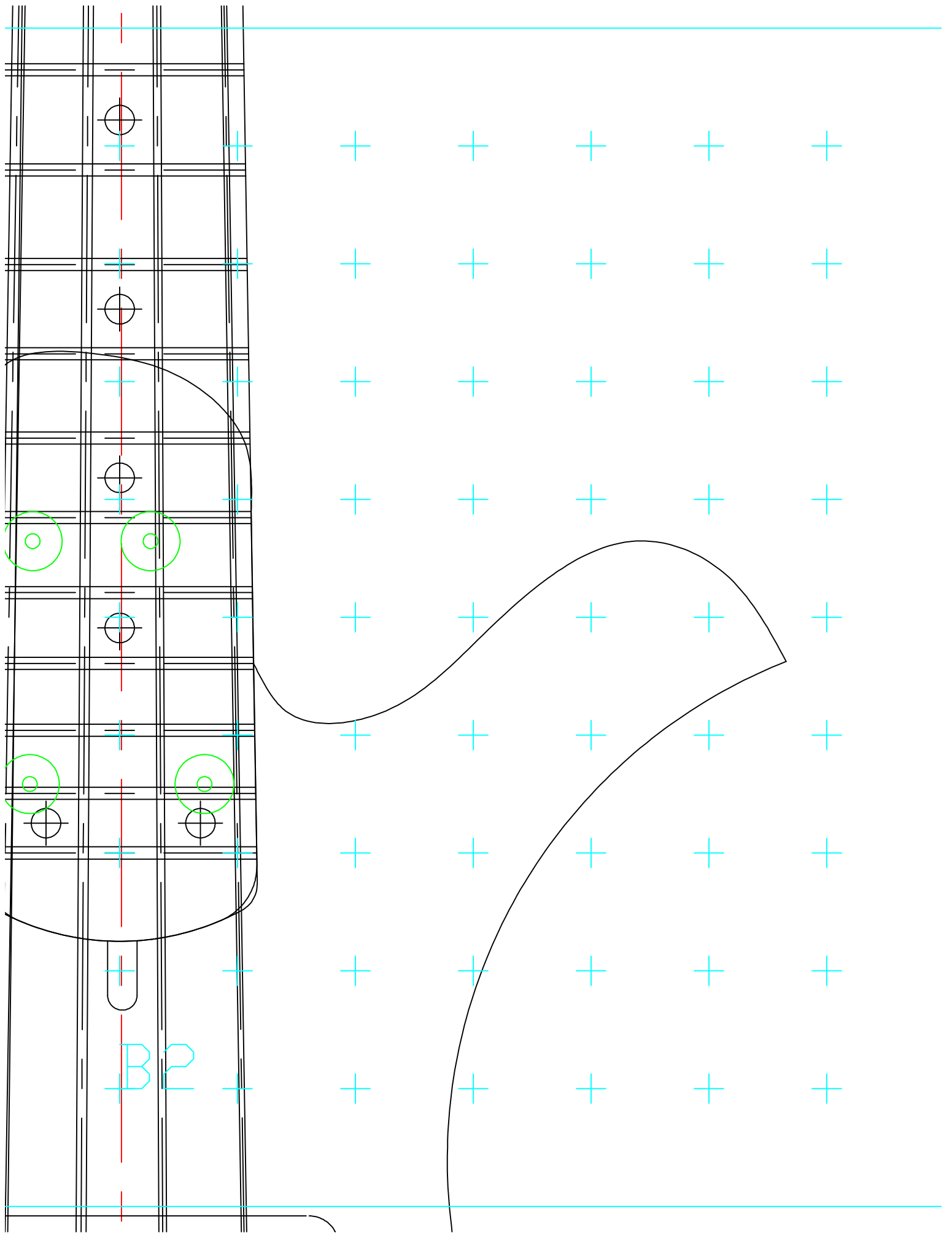

+	+	+	+	+	+	+	+
+	+	+	+	+	+	+	+
+	+	+	+	+	+	+	+
+	+	+	+	+	+	+	+
+	+	+	+	+	+	+	+
+	+	+	+	+	+	+	+
+	+	+	+	+	+	+	+
+	+	+	+	+	+	+	+
+	+	+	+	+	+	+	+
+	+	+	+	+	+	+	+
B3	+	+	+	+	+	+	+

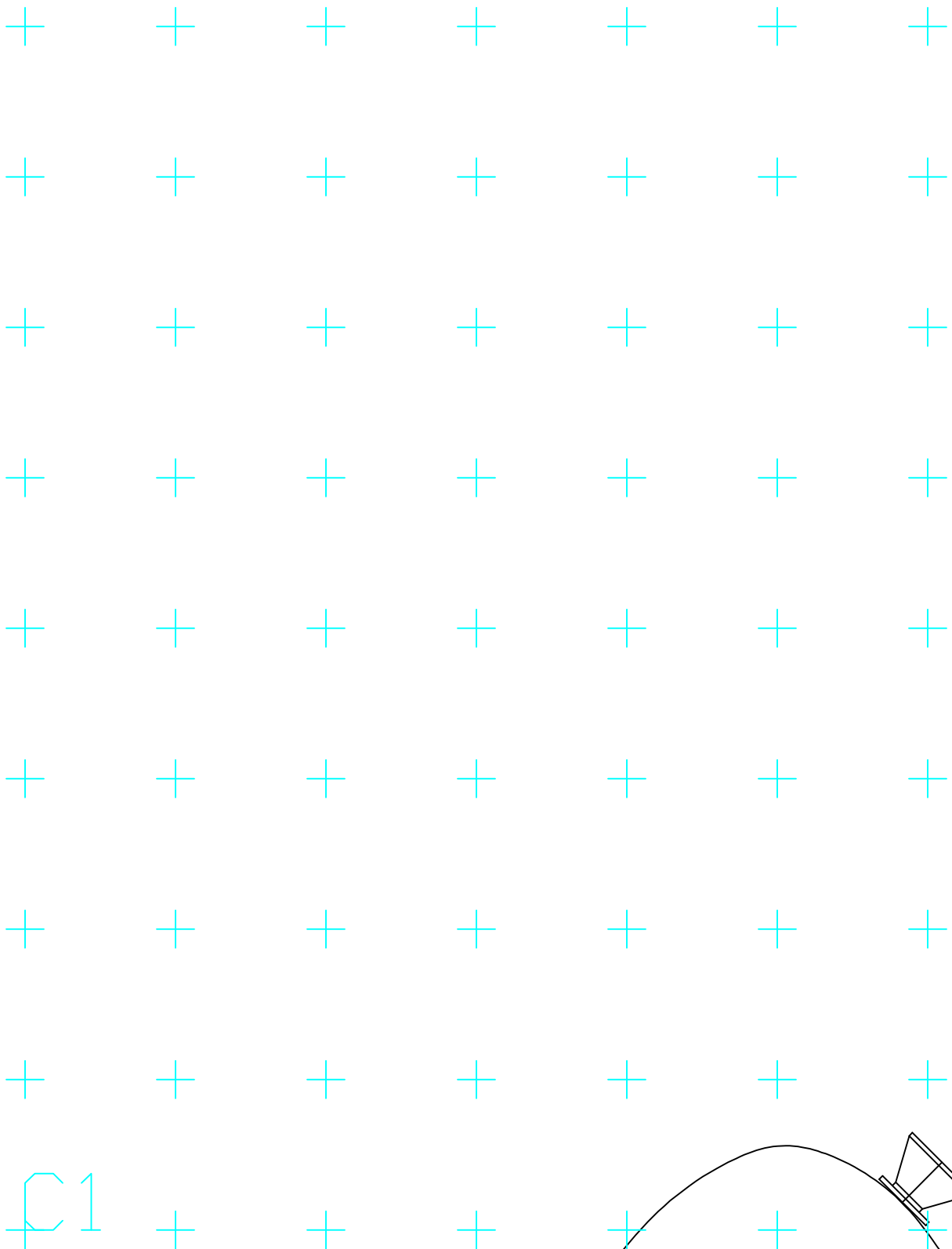
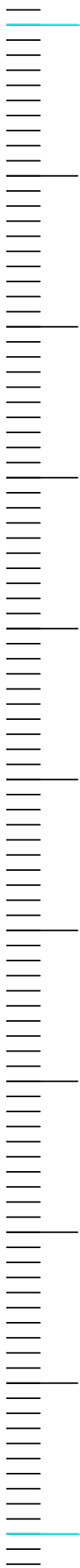

C1

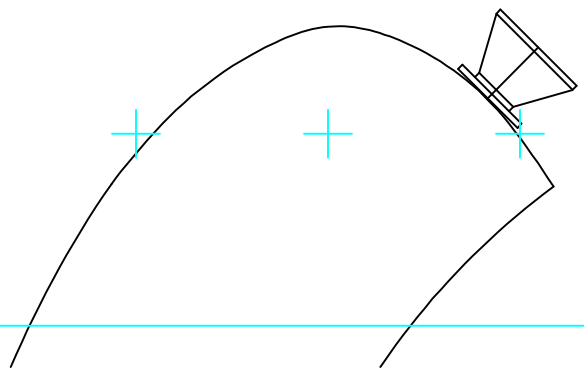

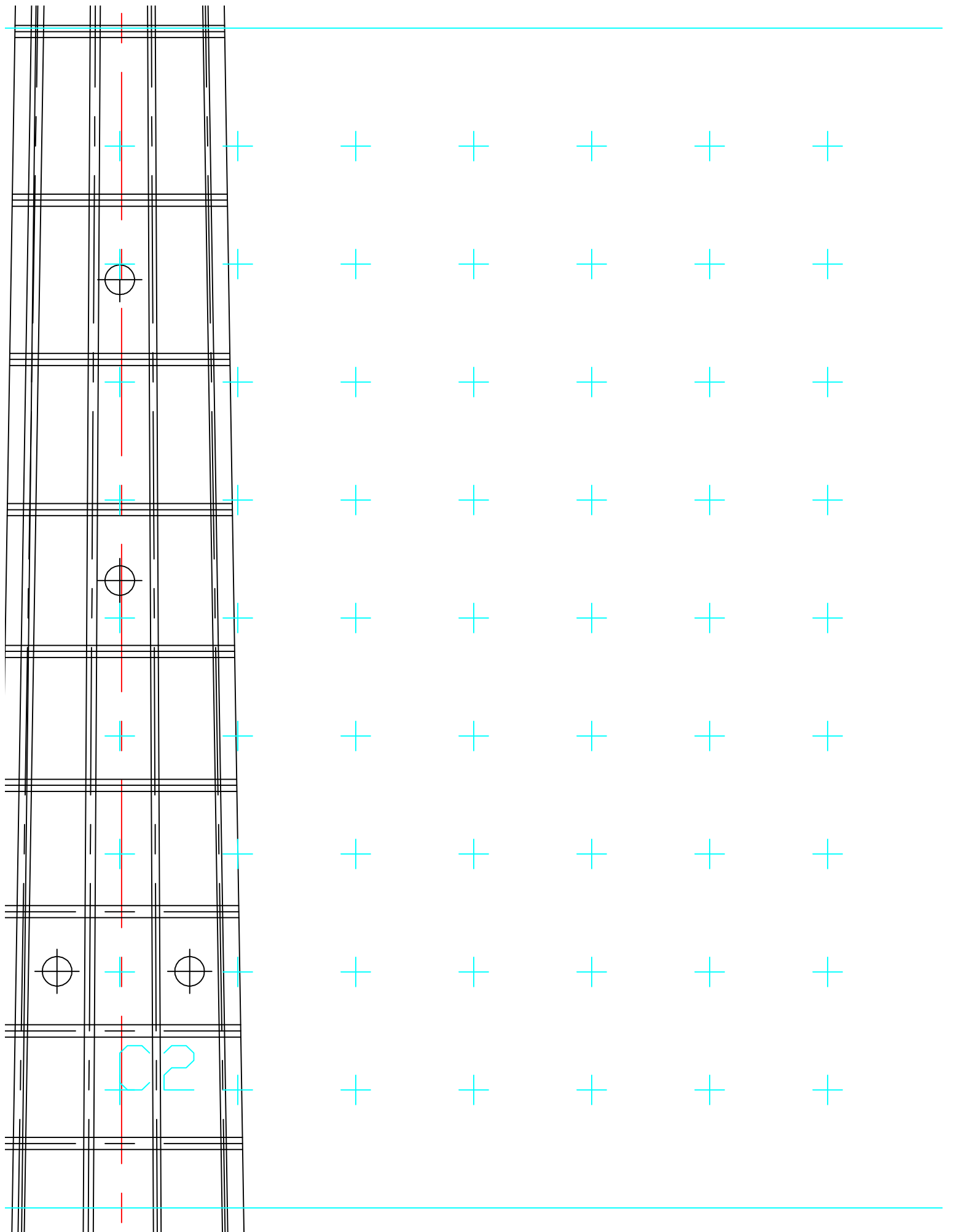



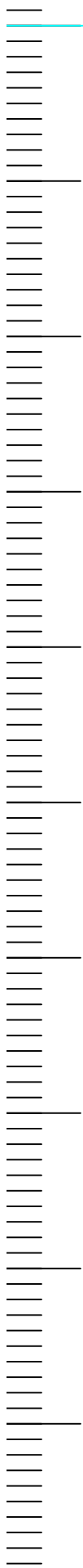

+ + + + + + +

+ + + + + + +

+ + + + + + +

+ + + + + + +

+ + + + + + +

+ + + + + + +

+ + + + + + +

+ + + + + + +

+ D1 + + + + + + +



Scale: 1:1

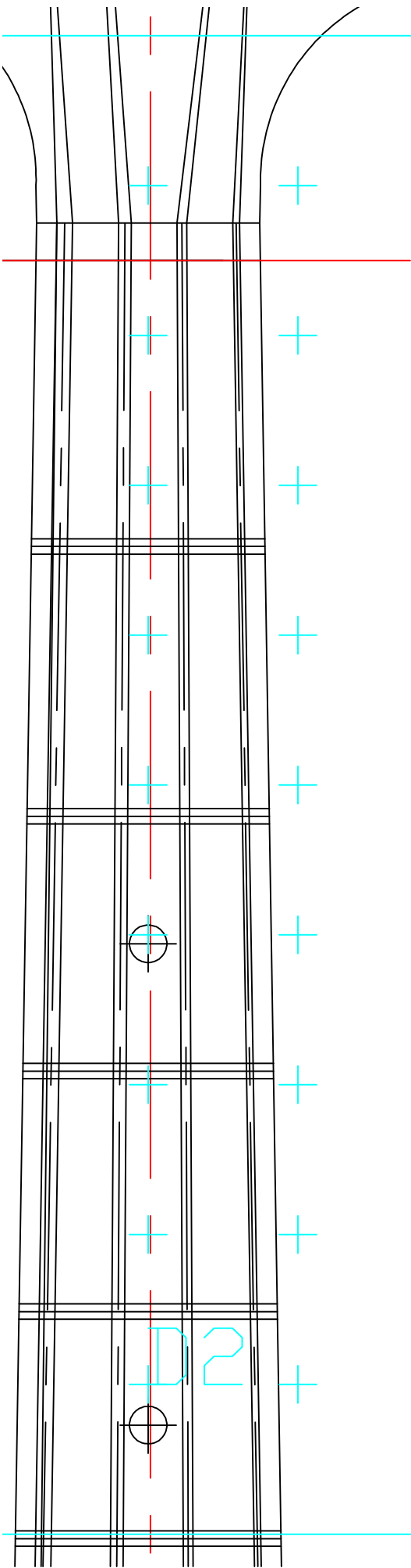

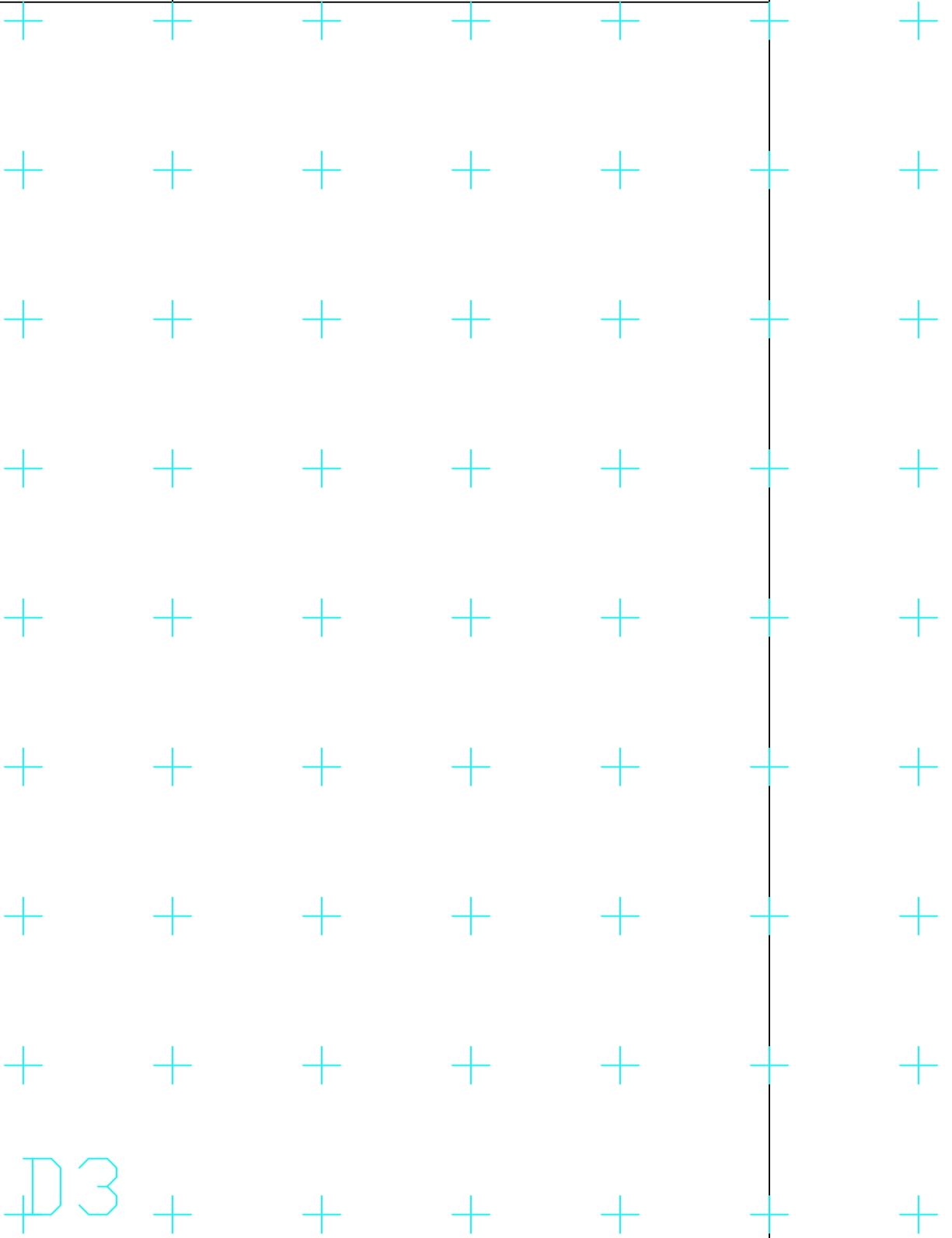

+ + + + + + +

+ + + + + + +

+ + + + + + +

+ + + + + + +

+ + + + + + +

+ + + + + + +

+ + + + + + +

+ + + + + + +

F1

+ + + + + + +

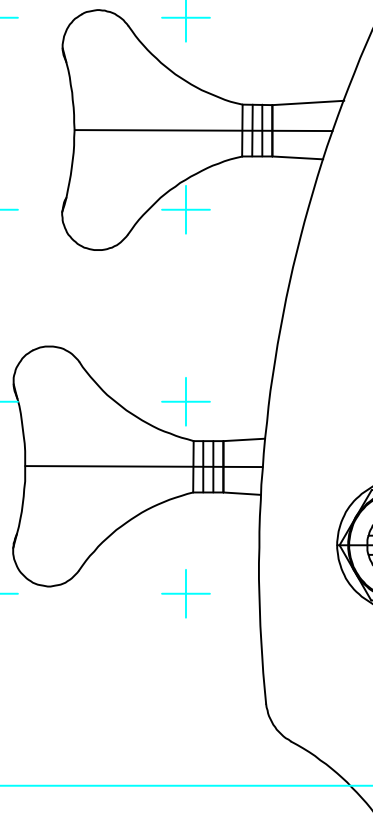

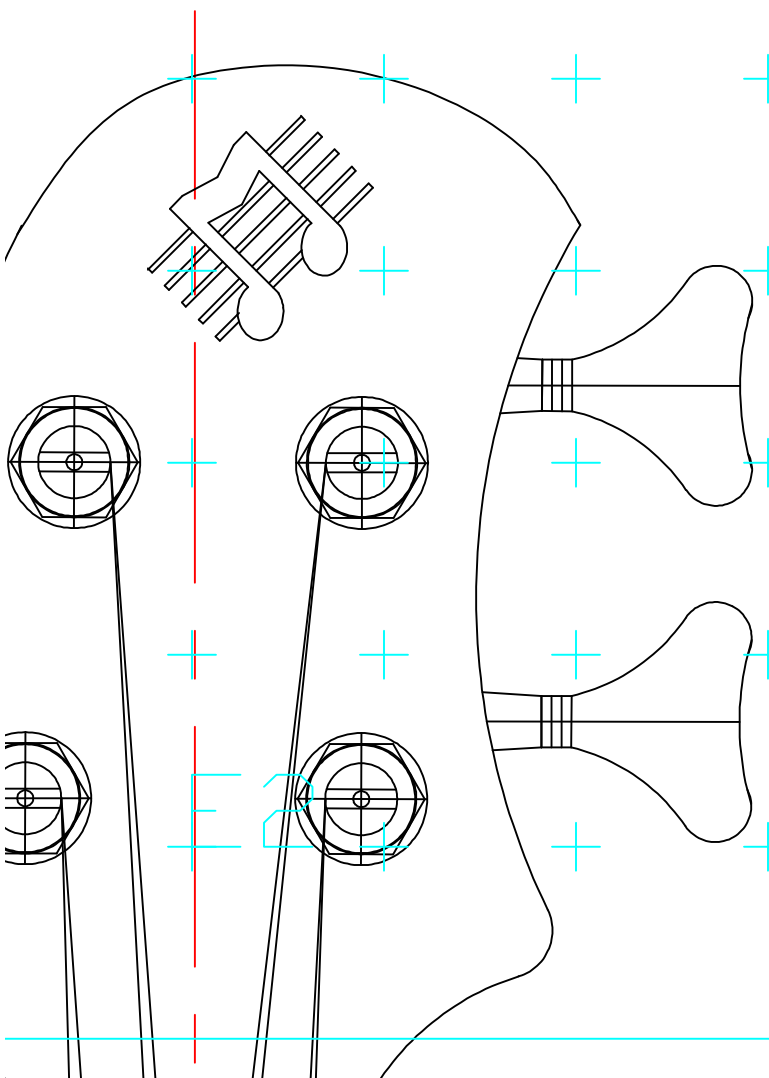

*liutaio*  
**Motta**  
*handcrafted stringed instr*

*Title:*

Mezzaluna El  
Standard -

*Drawn by:*

RMM

*Code Ident No:*

*Size:*

24  
x  
48

***Mottola***

***struments***

**rm@LiutaioMottola.com**

Electric Bass Family  
- 34" scale

***Date:*** 4/26/02

***Size:*** ***Drawing No:***

4

8